



8-Channel LCD and Camera EMI Filter Array with ESD Protection

CM1408-08DE

Features

- Eight channels of EMI filtering with integrated ESD protection
- Pi-style EMI filters in a capacitor-resistor-capacitor (C-R-C) network
- $\pm 15\text{kV}$ ESD protection on each channel (IEC 61000-4-2 Level 4, contact discharge)
- $\pm 30\text{kV}$ ESD protection on each channel (HBM)
- Greater than -35dB attenuation (typical) at 1GHz
- TDFN packaging with 0.5mm lead pitch:
 - 16-lead TDFN, $4.0\text{mm} \times 1.60\text{mm}$
- Increased robustness against vertical impacts during manufacturing process
- Lead-free finishing

Applications

- LCD and Camera data lines in mobile handsets
- I/O port protection for mobile handsets, notebook computers, PDAs etc.
- EMI filtering for data ports in cell phones, PDAs or notebook computers.
- Wireless handsets
- Handheld PCs/PDAs
- LCD and camera modules

Block Diagram

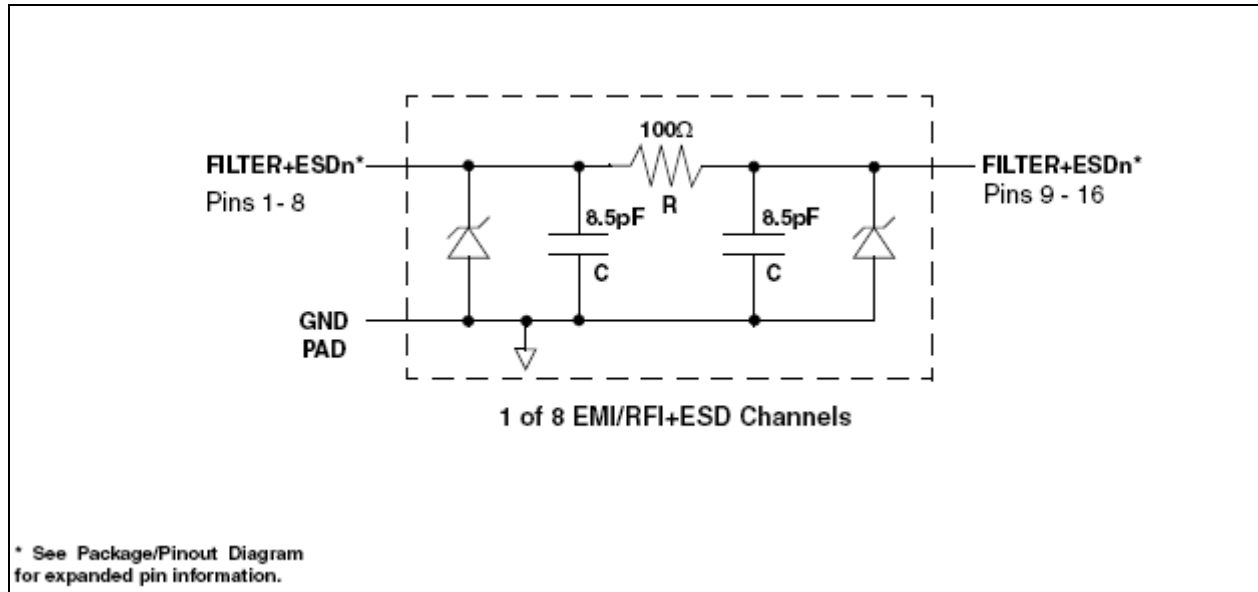

PACKAGE / PINOUT DIAGRAMS

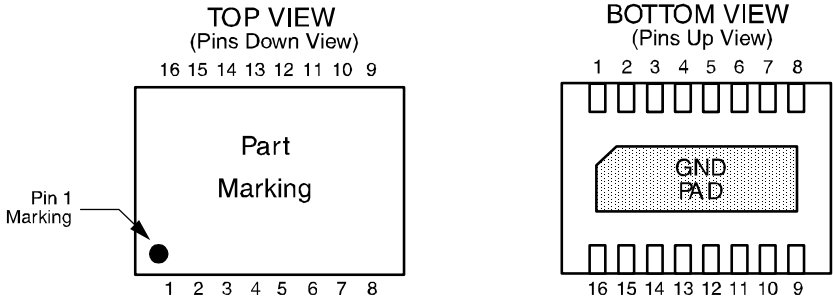

16 Lead TDFN Package

Note:
1) These drawings are not to scale.

PIN DESCRIPTIONS

DEVICE PIN(s)	NAME	DESCRIPTION	DEVICE PIN(s)	NAME	DESCRIPTION
1	FILTER1	Filter + ESD Channel 1	16	FILTER1	Filter + ESD Channel 1
2	FILTER2	Filter + ESD Channel 2	15	FILTER2	Filter + ESD Channel 2
3	FILTER3	Filter + ESD Channel 3	14	FILTER3	Filter + ESD Channel 3
4	FILTER4	Filter + ESD Channel 4	13	FILTER4	Filter + ESD Channel 4
5	FILTER5	Filter + ESD Channel 5	12	FILTER5	Filter + ESD Channel 5
6	FILTER6	Filter + ESD Channel 6	11	FILTER6	Filter + ESD Channel 6
7	FILTER7	Filter + ESD Channel 7	10	FILTER7	Filter + ESD Channel 7
8	FILTER8	Filter + ESD Channel 8	9	FILTER8	Filter + ESD Channel 8
GND PAD	GND	Device Ground	-	-	-

CM1408-08DE

Ordering Information

PART NUMBERING INFORMATION			
Pins	Package	Lead-free Finish	
		Ordering Part Number ¹	Part Marking
16	TDFN-16	CM1408-08DE	N088E

Note 1: Parts are shipped in Tape & Reel form unless otherwise specified.

Specifications

ABSOLUTE MAXIMUM RATINGS		
PARAMETER	RATING	UNITS
Storage Temperature Range	-65 to +150	°C
DC Power per Resistor	100	mW
DC Package Power Rating	500	mW

STANDARD OPERATING CONDITIONS		
PARAMETER	RATING	UNITS
Operating Temperature Range	-40 to +85	°C

ELECTRICAL OPERATING CHARACTERISTICS (SEE NOTE1)

SYMBOL	PARAMETER	CONDITIONS	MIN	TYP	MAX	UNITS
R	Resistance		80	100	120	Ω
C _{TOTAL}	Total Channel Capacitance	At 2.5VDC Reverse Bias, 1MHz, 30mVAC	14	17	22	pF
C	Capacitance C	At 2.5VDC Reverse Bias, 1MHz, 30mVAC		8.5		pF
V _{DIODE}	Standoff Voltage	I _{DIODE} =10 μ A		6.0		V
I _{LEAK}	Diode Leakage Current (reverse bias)	V _{DIODE} = 3.3V		0.1	1.0	μ A
V _{SIG}	Signal Clamp Voltage Positive Clamp Negative Clamp	I _{LOAD} = 10mA I _{LOAD} = -10mA	5.6 -1.5	6.8 -0.8	9.0 -0.4	V V
V _{ESD}	In-system ESD Withstand Voltage a) Human Body Model, MIL-STD-883, Method 3015 b) Contact Discharge per IEC 61000-4-2 Level 4	Note 2	\pm 30 \pm 15			kV kV
R _{DYN}	Dynamic Resistance Positive Negative			2.3 0.9		Ω Ω
f _C	Cut-off Frequency Z _{SOURCE} =50 Ω , Z _{LOAD} =50 Ω	Channel R = 100 Ω , Channel C _{SINGLE} = 8.5pF		200		MHz

Note 1: T_A=25 °C unless otherwise specified.

Note 2: ESD applied to input and output pins with respect to GND, one at a time.

Performance Information

Typical EMI Filter Performance ($T_A=25^\circ\text{C}$, DC Bias=0V, 50 Ohm Environment)

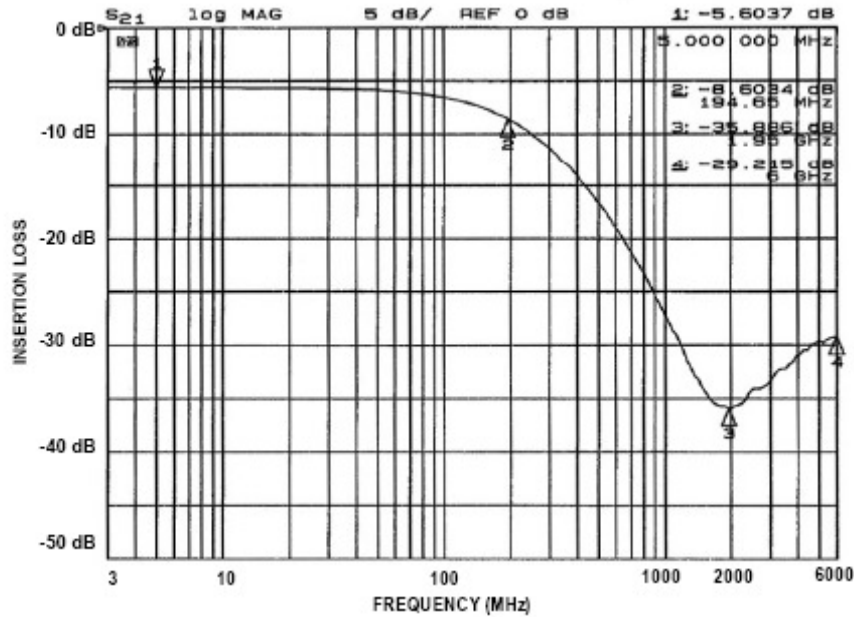

Figure 1. Insertion Loss vs. Frequency (Filter 1 Input – Pin 1 to Pin 16)

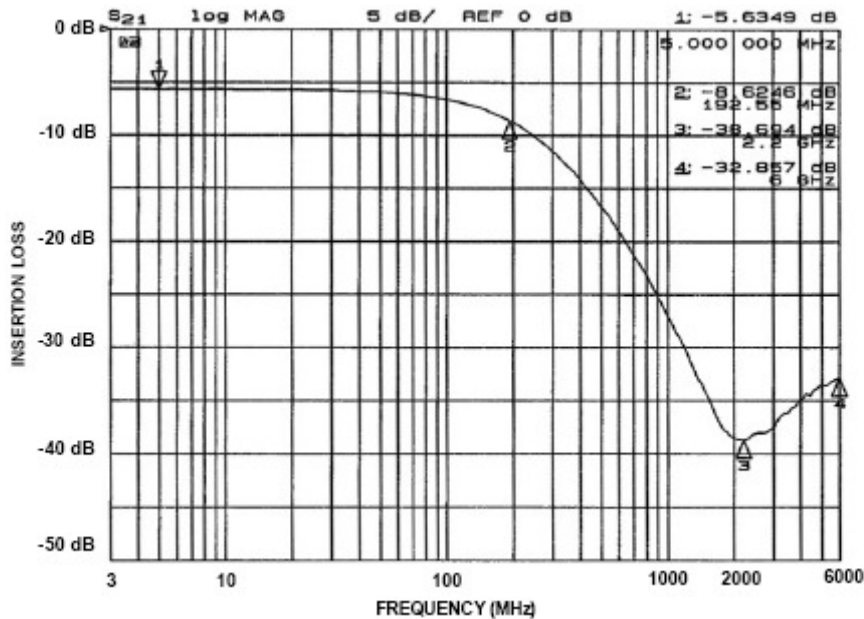

Figure 2. Insertion Loss vs. Frequency (Filter 2 Input – Pin 2 to Pin 15)

Performance Information (cont'd)

Typical EMI Filter Performance ($T_A=25^\circ\text{C}$, DC Bias=0V, 50 Ohm Environment)

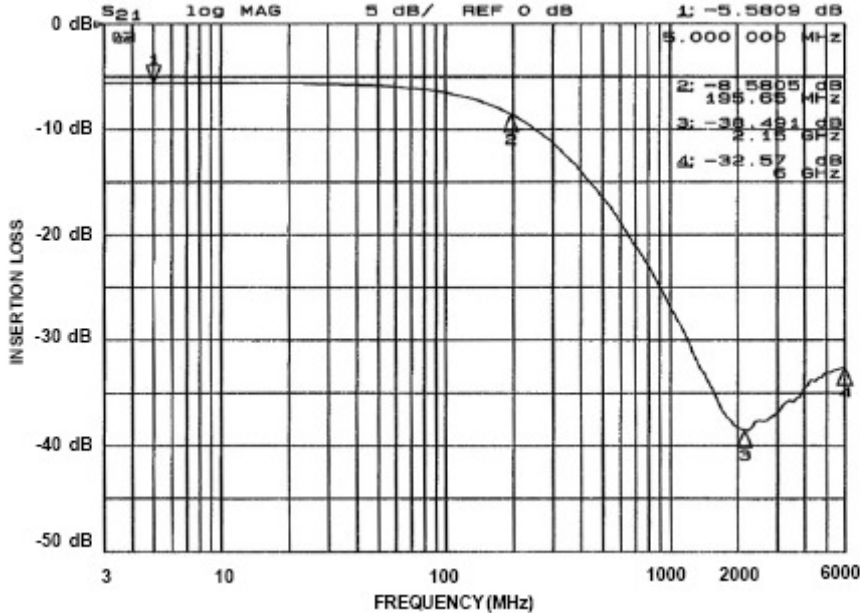

Figure 3. Insertion Loss vs. Frequency (Filter 3 Input – Pin 3 to Pin 14)

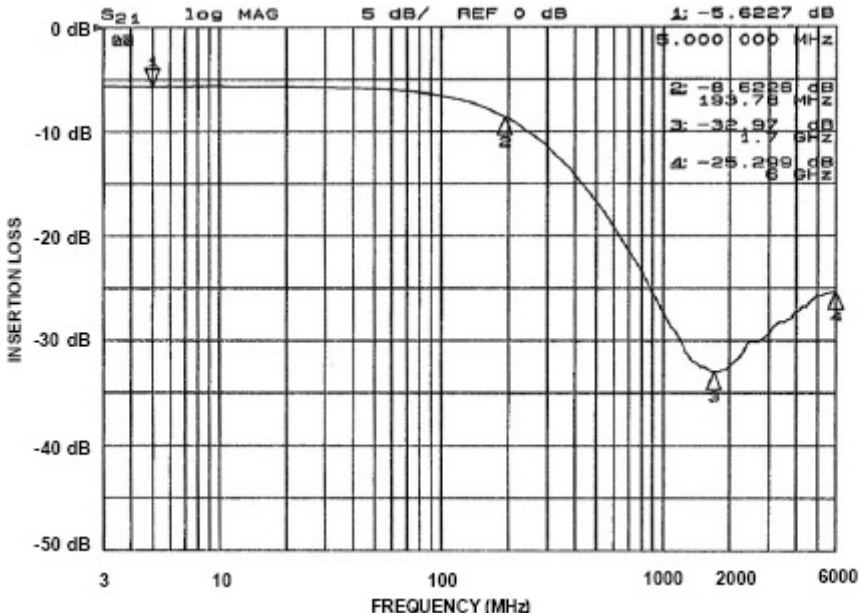

Figure 4. Insertion Loss vs. Frequency (Filter 4 Input – Pin 4 to Pin 13)

Performance Information (cont'd)

Typical EMI Filter Performance ($T_A=25^\circ\text{C}$, DC Bias=0V, 50 Ohm Environment)

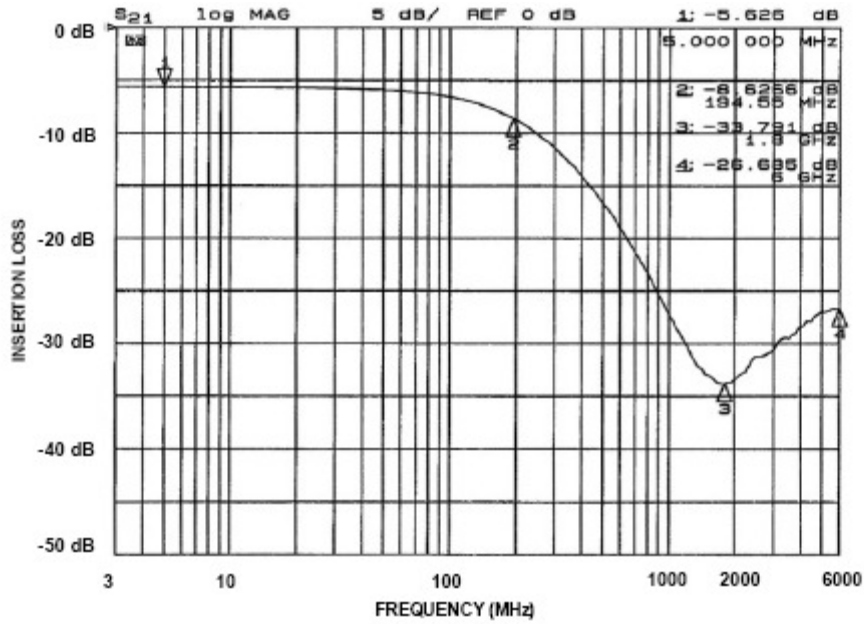

Figure 5. Insertion Loss vs. Frequency (Filter 5 Input – Pin 5 to Pin 12)

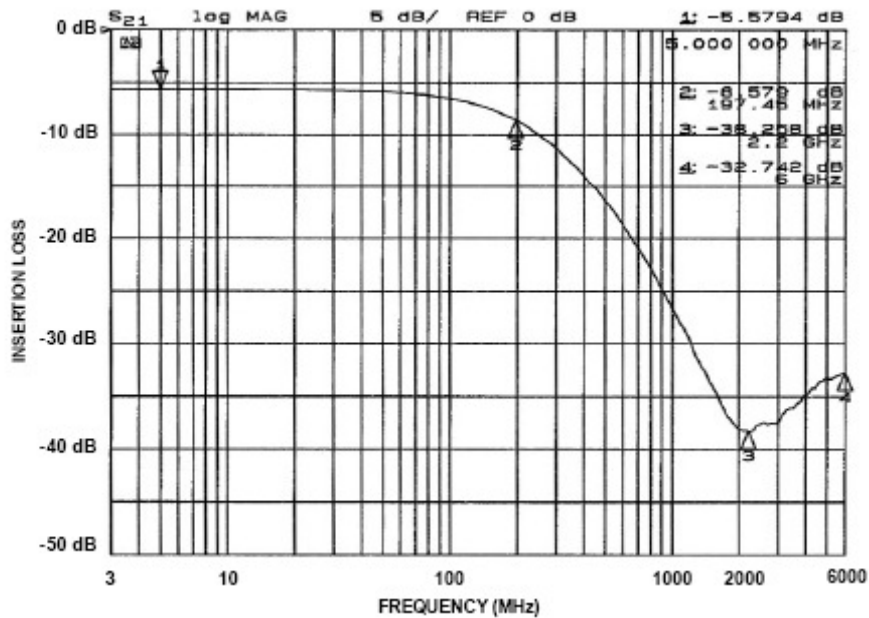

Figure 6. Insertion Loss vs. Frequency (Filter 6 Input – Pin 6 to Pin 11)

Performance Information (cont'd)

Typical EMI Filter Performance ($T_A=25^\circ\text{C}$, DC Bias=0V, 50 Ohm Environment)

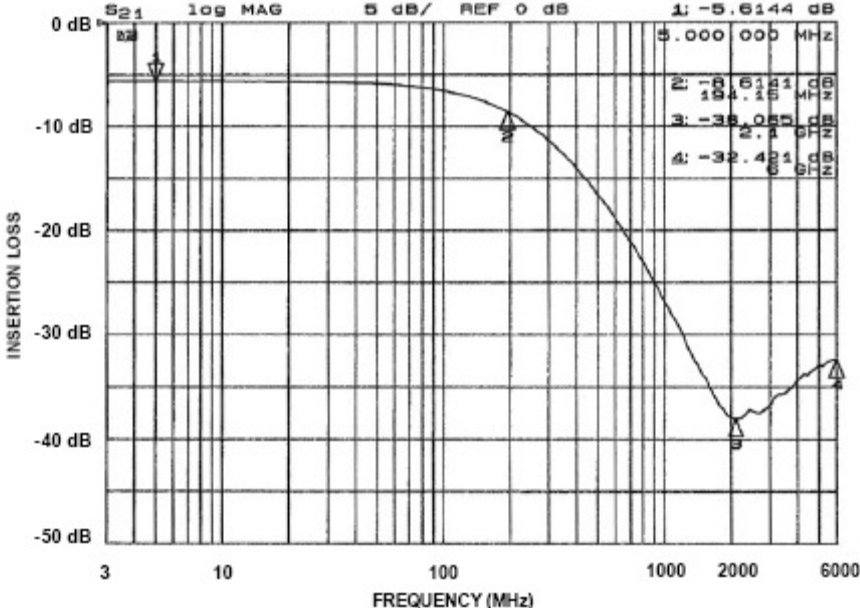

Figure 7. Insertion Loss vs. Frequency (Filter 7 Input – Pin 7 to Pin 10)

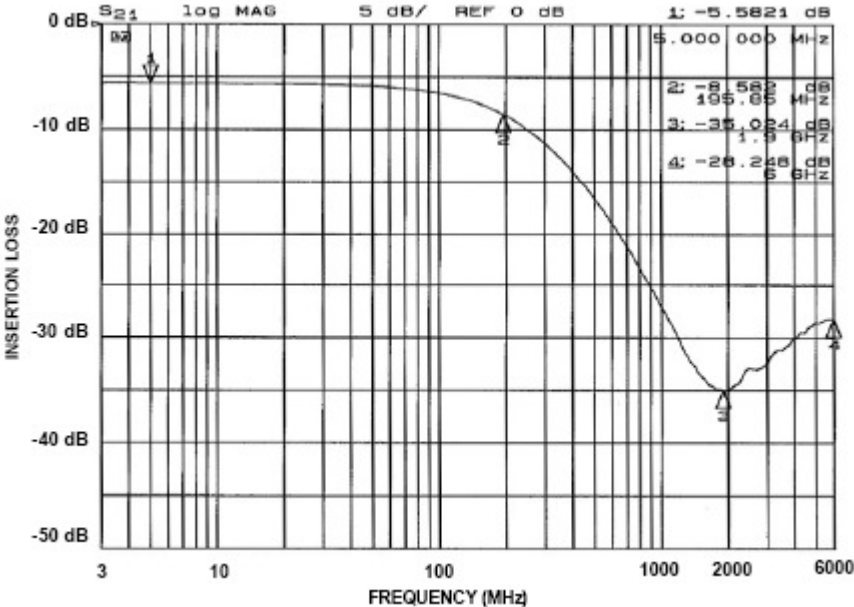
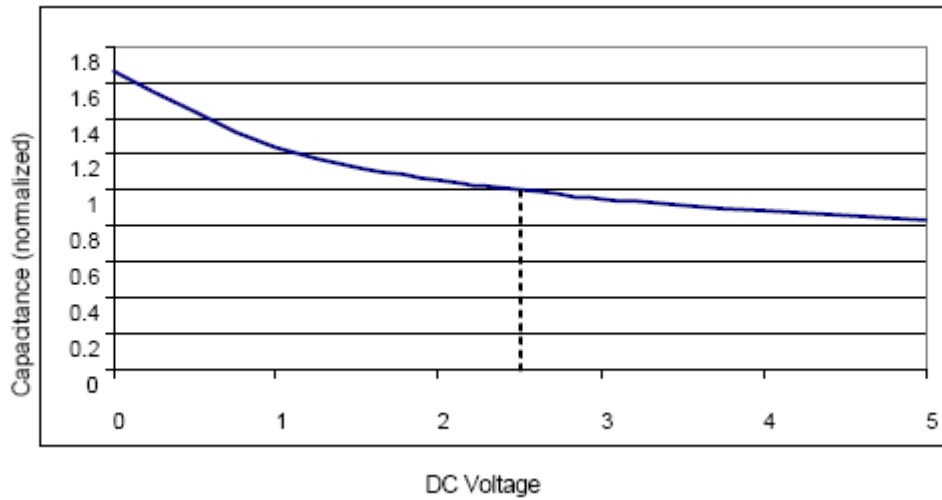

Figure 8. Insertion Loss vs. Frequency (Filter 8 Input – Pin 8 to Pin 9)

Performance Information (cont'd)

Typical Diode Capacitance vs. Input Voltage



**Figure 9. Filter Capacitance vs. Input Voltage
(normalized to capacitance at 2.5VDC and 25°C)**

Mechanical Details

TDFN-16EEP Mechanical Specifications

The CM1408-08DE is supplied in a 16-lead, 0.5mm pitch TDFN package with Exposed End Pads (EEP). Dimensions are presented below.

PACKAGE DIMENSIONS						
Package	TDFN					
JEDEC No.	MO-229C [†]					
Leads	16					
Dim.	Millimeters			Inches		
	Min	Nom	Max	Min	Nom	Max
A	0.70	0.75	0.80	0.028	0.030	0.031
A3	0.20 REF			0.008 REF		
b	0.20	0.25	0.30	0.008	0.010	0.012
D	3.90	4.00	4.10	0.153	0.157	0.161
D2	3.10	3.20	3.30	0.122	0.126	0.130
E	1.50	1.60	1.70	0.059	0.063	0.067
E2	0.30	0.40	0.50	0.012	0.016	0.020
e	0.50 BSC			0.020 BSC		
K	0.20			0.008		
L	0.20	0.30	0.40	0.008	0.010	0.012
M	0.25 REF			0.010 REF		
# per tape and reel	3000 pieces					
Controlling dimension: millimeters						

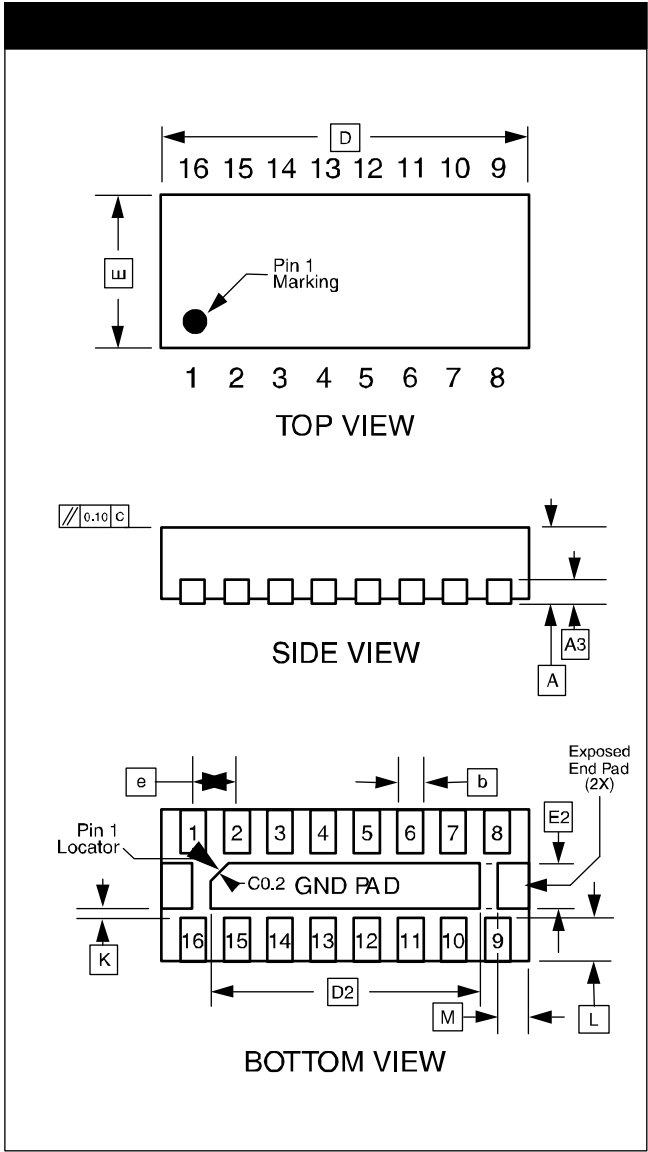

Dimensions for 16-Lead, 0.5mm pitch TDFN package with Exposed End Pads (EEP)

[†] This package is compliant with JEDEC standard MO-229C with the exception of the "D", "D2", "E", "E2", "K" and "L" dimensions as called out in the table above.

CM1408-08DE

Tape and Reel Specifications

PART NUMBER	PACKAGE SIZE (mm)	POCKET SIZE (mm) $B_o \times A_o \times K_o$	TAPE WIDTH W	REEL DIAMETER	QTY PER REEL	P_o	P_1
CM1408-08DE	4.00 X 1.60 X 0.75	4.30 X 1.90 X 1.20	12mm	178mm (7")	3000	4mm	4mm

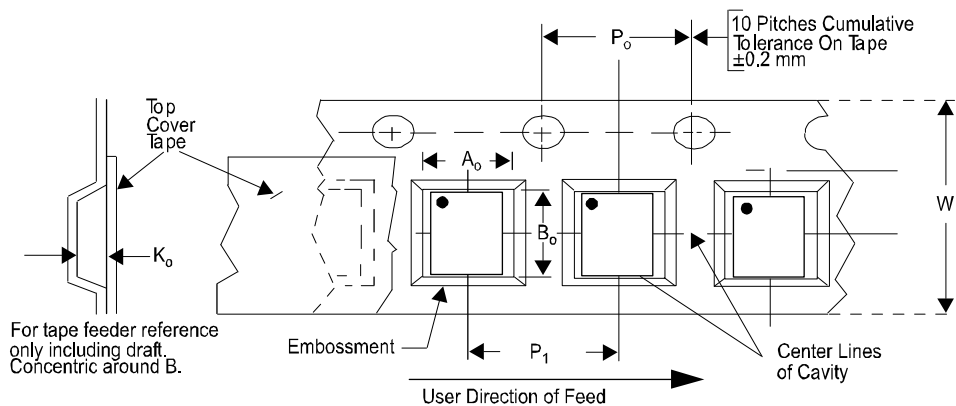

ON Semiconductor and  are registered trademarks of Semiconductor Components Industries, LLC (SCILLC). SCILLC reserves the right to make changes without further notice to any products herein. SCILLC makes no warranty, representation or guarantee regarding the suitability of its products for any particular purpose, nor does SCILLC assume any liability arising out of the application or use of any product or circuit, and specifically disclaims any and all liability, including without limitation special, consequential or incidental damages. "Typical" parameters which may be provided in SCILLC data sheets and/or specifications can and do vary in different applications and actual performance may vary over time. All operating parameters, including "Typicals" must be validated for each customer application by customer's technical experts. SCILLC does not convey any license under its patent rights nor the rights of others. SCILLC products are not designed, intended, or authorized for use as components in systems intended for surgical implant into the body, or other applications intended to support or sustain life, or for any other application in which the failure of the SCILLC product could create a situation where personal injury or death may occur. Should Buyer purchase or use SCILLC products for any such unintended or unauthorized application, Buyer shall indemnify and hold SCILLC and its officers, employees, subsidiaries, affiliates, and distributors harmless against all claims, costs, damages, and expenses, and reasonable attorney fees arising out of, directly or indirectly, any claim of personal injury or death associated with such unintended or unauthorized use, even if such claim alleges that SCILLC was negligent regarding the design or manufacture of the part. SCILLC is an Equal Opportunity/Affirmative Action Employer. This literature is subject to all applicable copyright laws and is not for resale in any manner.

PUBLICATION ORDERING INFORMATION

LITERATURE FULFILLMENT:

Literature Distribution Center for ON Semiconductor
P.O. Box 5163, Denver, Colorado 80217 USA
Phone: 303-675-2175 or 800-344-3860 Toll Free USA/Canada
Fax: 303-675-2176 or 800-344-3867 Toll Free USA/Canada
Email: orderlit@onsemi.com

N. American Technical Support: 800-282-9855
Toll Free USA/Canada
Europe, Middle East and Africa Technical Support:
Phone: 421 33 790 2910
Japan Customer Focus Center
Phone: 81-3-5773-3850

ON Semiconductor website: www.onsemi.com

Order Literature: <http://www.onsemi.com/orderlit>

For additional information, please contact your local Sales Representative